

Table Of Contents

Pulls, Plates and Trim

Pulls	page
8102 Door Pull	.B2
8103 Door Pull	.B2
8103EZ Door Pull	.B3
8105 Door Pull	.B3
8111-5 Door Pull	.B4
8112-5 Door Pull	.B4
8121 Door Pull	.B5
8190 Offset Door Pull	.B5

Push and Pull Plates

8200 Push Plate	.B6
8300 Pull Plate (less pull)	.B6
8302 Pull Plate	.B7
8303 Pull Plate	.B7
8305 Pull Plate (with 8105)	.B7
8311 Pull Plate (with 8111-5)	.B8

Push Bars

9100 Pushbar	.B8
9103EZ Pushbar & Pull	.B9
9190 Pushbar & Pull	.B9

Vandal Resistant Trim

VR810-DT, VR814DT Vandal Resistant Trim	.B10
VR810-NL, VR814-NL Vandal Resistant Trim	.B10
VR900, VR904 Vandual Resistant Trim	.B11
VR900LLP, VR904LLP Vandual Resistant Trim	.B11
VR910-DT, VR914-DT Vandual Resistant Trim	.B12
VR910-NL, VR914-NL Vandual Resistant Trim	.B12
VR910M-DT, VR914M-DT Vandual Resistant trim	.B12
VR910M-NL, VR914M-NL Vandual Resistant Trim	.B12

Protection Plates

8400 Protection Plate	.B13-14
8402 Protection Plate (UL)	.B13-14

Mounting Detail

Special Mounting Detail	.B15-17
-------------------------	---------



A
Hinges & Pivots

B2
Pulls & Plates

C
Flush Bolts & Coordinators

D
Latches, Catches & Bolts

E
Stops

F
Exterior Hardware

G
Miscellaneous Hardware

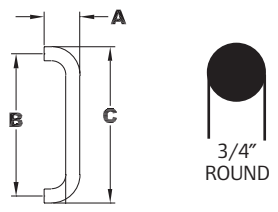

8102 Door Pull - 3/4" Round

Available mounting – standard, F, H-I-L, or J see pages B15 and B16

Available Sizes

6", 8", 10"

Product No.	Projection "A"	Clearance	Center to Center "B"	Overall Length "C"
8102-6	2-1/4"	1-1/2"	6"	6-3/4"
8102-8	2-1/4"	1-1/2"	8"	8-3/4"
8102-0	2-1/4"	1-1/2"	10"	10-3/4"

Finishes brass

US Number	US3	US4	US10	US10B	US15	US26	US26D*
BHMA	605	606	612	613	619	625	626

Finishes stainless steel

US Number	US32D*
BHMA	630

Finishes aluminum

US Number	US28
BHMA	628

* Available with Antimicrobial Coating, use suffix AM

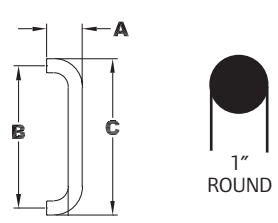

8103 Door Pull - 1" Round

Available mounting – standard, F, H-I-L, or J see pages B15 and B16

Available Sizes

8", 10", 12"

Product No.	Projection "A"	Clearance	Center to Center "B"	Overall Length "C"
8103-8	2-1/2"	1-1/2"	8"	9"
8103-0	2-1/2"	1-1/2"	10"	11"
8103-2	2-1/2"	1-1/2"	12"	13"

Finishes brass

US Number	US3	US4	US10	US10B	US15	US26	US26D*
BHMA	605	606	612	613	619	625	626

Finishes stainless steel

US Number	US32	US32D*
BHMA	629	630

Finishes aluminum

US Number	US28
BHMA	628

* Available with Antimicrobial Coating, use suffix AM



8103EZ Door Pull - 1" Round
Large 2-1/2" Clearance for the Accessibility Applications

Available mounting – standard, M, O, H-I-L, J see pages B15 and B17

Available Sizes

8", 10", 12"

Product No.	Projection "A"	Clearance	Center to Center "B"	Overall Length "C"
8103EZ	3-1/2"	2-1/2"	8"	9"
8103EZ	3-1/2"	2-1/2"	10"	11"
8103EZ	3-1/2"	2-1/2"	12"	13"

Finishes brass

US Number	US3	US4	US10	US10B	US15	US26	US26D*
BHMA	605	606	612	613	619	625	626

Finishes stainless steel

US Number	US32	US32D*
BHMA	629	630

Finishes aluminum

US Number	US28
BHMA	628

* Available with Antimicrobial Coating, use suffix AM

8105 Door Pull - 1" Flattened

Available mounting – standard or F see page B15

Available Sizes

6", 8", 10"

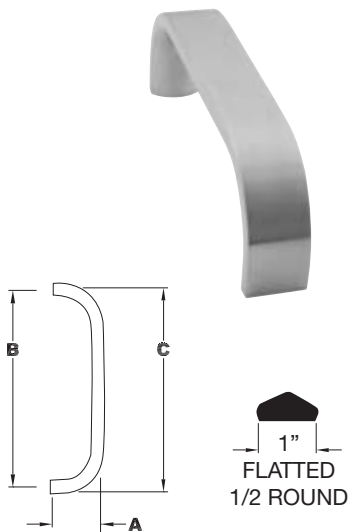

Product No.	Projection "A"	Center to Center "B"	Overall Length "C"
8105-6	2"	6"	6-1/2"
8105-8	2"	8"	8-1/2"
8105-0	2"	10"	10-1/2"

Finishes brass

US Number	US3	US4	US10	US10B	US15	US26	US26D*
BHMA	605	606	612	613	619	625	626

Finishes stainless steel

US Number	US32D*
BHMA	630

Finishes aluminum

US Number	US28
BHMA	628

* Available with Antimicrobial Coating, use suffix AM

A
Hinges & Pivots

B3
Pulls & Plates

C
Flush Bolts & Coordinators

D
Latches, Catches & Bolts

E
Stops

F
Exterior Hardware

G
Miscellaneous Hardware

A
Hinges & Pivots

B4
Pulls & Plates

C
Flush Bolts & Coordinators

D
Latches, Catches & Bolts

E
Stops

F
Exterior Hardware

G
Miscellaneous Hardware

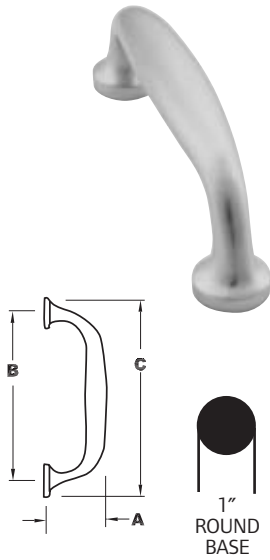

8111-5 Door Pull

Available mounting – standard see page B15

Size

5-1/4"

Product No.	Projection "A"	Center to Center "B"	Overall Length "C"
8111-5	1-13/16"	5-1/4"	6-1/4"

Finishes *brass*

US Number	US3	US4	US10	US10B	US15	US26	US26D*
BHMA	605	606	612	613	619	625	626

Finishes *stainless steel*

US Number	US32D*
BHMA	630

Finishes *aluminum*

US Number	US28
BHMA	628

* Available with Antimicrobial Coating, use suffix AM

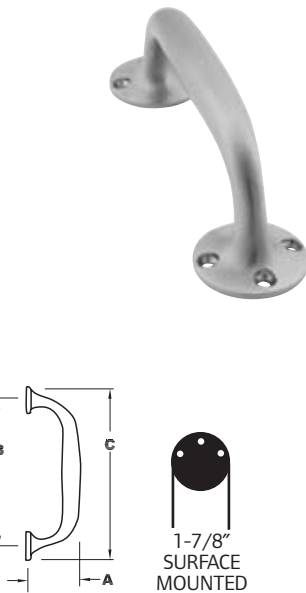

8112-5 Door Pull

Standard sheet metal screws for surface mounting

Size

5-1/4"

Product No.	Projection "A"	Center to Center "B"	Overall Length "C"
8112-5	2-13/16"	5-5/8"	7-1/2"

Finishes *brass*

US Number	US26D*
BHMA	626

* Available with Antimicrobial Coating, use suffix AM

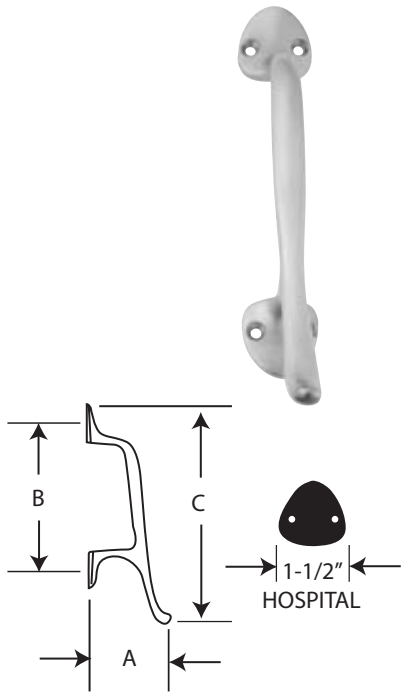

8121 Door Pull

Available mounting – K see page B16

Size

5-3/4"

Product No.	Projection "A"	Center to Center "B"	Overall Length "C"
8121-5	3-1/2"	5-3/4"	8-3/4"

Finishes *brass*

US Number	US26D*
BHMA	626

* Available with Antimicrobial Coating, use suffix AM

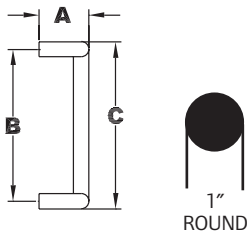

8190 90° Offset Door Pull

Available mounting – standard H-I-L, M, N or O see page B15 and B17

Available Sizes

8", 10", 12", 18"

Product No.	Projection "A"	Clearance	Center to Center "B"	Overall Length "C"
8190-8	3-1/4"	2-1/4"	8"	9"
8190-0	3-1/4"	2-1/4"	10"	11"
8190-2	3-1/4"	2-1/4"	12"	13"
8190-18	3-1/4"	2-1/4"	18"	19"

Finishes *brass*

US Number	US3	US4	US10	US10B	US15	US26	US26D*
BHMA	605	606	612	613	619	625	626

Finishes *stainless steel*

US Number	US32	US32D*
BHMA	629	630

* Available with Antimicrobial Coating, use suffix AM

A
Hinges & Pivots

B5
Pulls & Plates

C
Flush Bolts & Coordinators

D
Latches, Catches & Bolts

E
Stops

F
Exterior Hardware

G
Miscellaneous Hardware

A
Hinges & Pivots

B6
Pulls & Plates

C
Flush Bolts & Coordinators

D
Latches, Catches & Bolts

E
Stops

F
Exterior Hardware

G
Miscellaneous Hardware



8200 Push Plate
8300 Pull Plate, Prep for Pull (less pull)

Available Sizes

- 3" x 12"
- 3.5" x 15"
- 4" x 16"
- 6" x 16"
- 8" x 16"

Special sizes are available. Consult factory.

Plates Cut for Cylinder or Thumbturns

Plates are available with cutout for cylinder or thumbturn; standard cutout is 2" from top and centered on plates up to 4" wide. For plates wider than 4" cutout is located 2" from outer edge, specify LH or RH. When pull location interferes with standard cutout location a detail drawing should be furnished with the order.

Standard cutout is 1-1/4" for cylinder and 3/8" for thumbturn.

Specify CFC for cutout for cylinder or CFT for cutout for thumbturn.

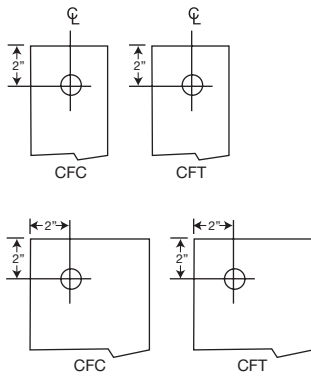

Finishes brass

US Number	US3	US4	US10	US10B	US15	US26	US26D*
BHMA	605	606	612	613	619	625	626

Finishes stainless steel

US Number	US32D*
BHMA	630

Finishes aluminum

US Number	US28
BHMA	628

* Available with Antimicrobial Coating, use suffix AM

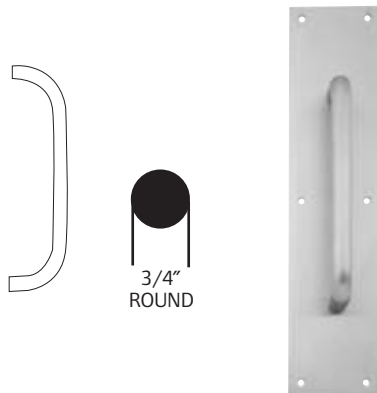

8302 Pull plate

Available mounting – Standard, F, G, H-I-L, or J see pages B15 and B16

8300 Plate	8102 Pull
3-1/2" x 15"	6" centers
4" x 16"	8" centers
6" x 16"	10" centers

Finishes brass

US Number	US3	US4	US10	US10B	US26	US26D*
BHMA	605	606	612	613	625	626

Finishes stainless steel

US Number	US32D*
BHMA	630

Finishes aluminum

US Number	US28
BHMA	628

* Available with Antimicrobial Coating, use suffix AM

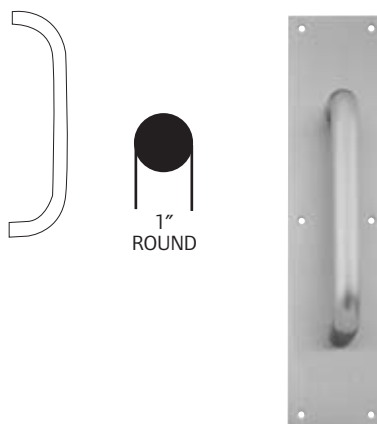

8303 Pull plate

Available mounting – Standard, F, G, H-I-L, or J see pages B15 and B16

8300 Plate	8103 Pull
3-1/2" x 15"	8" centers
4" x 16"	10" centers
6" x 16"	7" centers

Finishes brass

US Number	US3	US4	US10	US10B	US26	US26D*
BHMA	605	606	612	613	625	626

Finishes stainless steel

US Number	US32D*
BHMA	630

Finishes aluminum

US Number	US28
BHMA	628

* Available with Antimicrobial Coating, use suffix AM

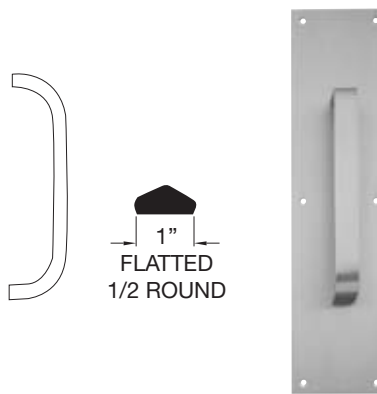

8305 Pull plate

Available mounting – Standard or F see page B15

8300 Plate	8105 Pull
3-1/2" x 15"	6" centers
4" x 16"	8" centers
6" x 16"	10" centers

Finishes brass

US Number	US3	US4	US10	US10B	US26	US26D
BHMA	605	606	612	613	625	626

Finishes stainless steel

US Number	US32D
BHMA	630

Finishes aluminum

US Number	US28
BHMA	628

* Available with Antimicrobial Coating, use suffix AM



8311 Pull plate

Available mounting – Standard or F see page B15

8300 Plate
 3-1/2" x 15"
 4" x 16"
 6" x 16"

8111-5 Pull
 5-1/8" centers

Finishes brass

US Number	US3	US4	US10	US10B	US26	US26D*
BHMA	605	606	612	613	625	626

Finishes stainless steel

US Number	US32D*
BHMA	630

Finishes aluminum

US Number	US28
BHMA	628

* Available with Antimicrobial Coating, use suffix AM

9100 Series Door Push Bars and Pulls

- Available in brass, stainless steel or aluminum.
- Standard fasteners furnished for 1-3/4" thick doors. Specify door thick if other than standard.
- Special lengths are available, contact customer service.

See page B17 for special mounting requirements.

Caution – the length of the pushbar should not interfere with the door jamb or cause a pinch point.

9100 Push Bar

Available mounting – NO or NS see page B17



Product No.	Projection	Clearance	Center to Center	Overall Length
9100-28	2-1/2"	1-1/2"	28"	29"
9100-33	2-1/2"	1-1/2"	33"	34"

Special lengths available, consult factory

Finishes brass

US Number	US3	US4	US10	US10B	US15	US26	US26D*
BHMA	605	606	612	613	619	625	626

Finishes stainless steel

US Number	US32	US32D*
BHMA	629	630

* Available with Antimicrobial Coating, use suffix AM

9103EZ Straight Pull/Pushbar Combo (8103EZ Pull + 9100 Push)

Available mounting – NO or NS see page B17

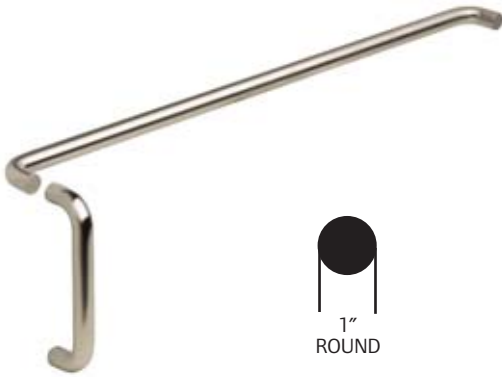

Product No.	CTC Push	CTC Pull	Projection Push & Pull
9103EZ	28", 33"	8"	2-1/2" & 3-1/2"
9103EZ	28", 33"	10"	2-1/2" & 3-1/2"
9103EZ	28", 33"	12"	2-1/2" & 3-1/2"

Special lengths available, consult factory

Finishes brass

US Number	US3	US4	US10	US10B	US15	US26	US26D*
BHMA	605	606	612	613	619	625	626

Finishes stainless steel

US Number	US32	US32D*
BHMA	629	630

* Available with Antimicrobial Coating, use suffix AM

9190 Offset Pull/Pushbar Combo (8190 pull + 9100 push)

Available mounting – NO or NS see page B17



Product No.	CTC Push	CTC Pull	Projection Push & Pull
9190	28", 33"	8"	2-1/2" & 3-1/4"
9190	28", 33"	10"	2-1/2" & 3-1/4"
9190	28", 33"	12"	2-1/2" & 3-1/4"
9190	28", 33"	18"	2-1/2" & 3-1/4"

Special lengths available, consult factory

Finishes brass

US Number	US3	US4	US10	US10B	US15	US26	US26D*
BHMA	605	606	612	613	619	625	626

Finishes stainless steel

US Number	US32	US32D*
BHMA	629	630

* Available with Antimicrobial Coating, use suffix AM

Vandal Resistant Trim

All stainless steel, 11 gauge (0.120" thick), using stainless steel fasteners for door thickness of 1-3/4" to 2-1/4". Built-in lock protector prevents tampering on certain models. Protective cylinder collar spins to reduce damage from pipe wrench or other tools. Models are available with or without attractive black plastisol edge grip.

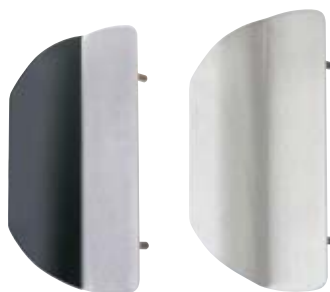

VR814

VR810

VR810-DT VR814-DT

With black grip Without black grip

- For use with Monarch XX, 18 Series or 25 Series rim exit device
- Non-handed
- Thru-bolts direct to the exit device
- Pull operation only

Prod. No.	Width	Height	Thru-Bolt Pattern	Clearance Grip to Door	Projection
VR810DT	5-1/4"	11"	1-3/4" Wide x 7-3/4" High	1-1/2"	1-7/8"

Finishes

US Finish	US32D
BHMA	630

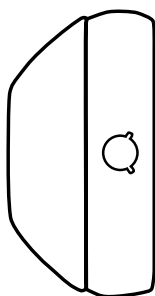

VR810-NL VR810-NL VR814-NL VR814-NL

LHR With black grip RHR With black grip LHR Without black grip RHR Without black grip

- For use with Monarch XX-V, 18-V Series or 25-V Series vertical rod exit device
- Thru-bolts direct to the exit device
- Night latch operation (cylinder not furnished)

Prod. No.	Width	Height	Thru-Bolt Pattern	Clearance Grip to Door	Projection
VR810NL	5-1/4"	11"	1-3/4" Wide x 7-3/4" High	1-1/2"	1-7/8"

Finishes

US Finish	US32D
BHMA	630

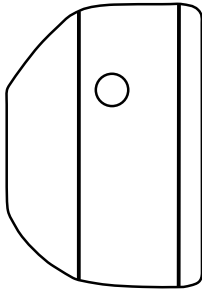

VR900 RHR With black grip
VR900 LHR With black grip
VR904 RHR Without black grip
VR904 LHR Without black grip

- For use with most mortise locks on outswinging doors including Schlage L9000 Series with interior L or N escutcheon, and rose trim.
- Includes built-in lock protector and cylinder cutout.
- Handed design allows trim to be positioned to coordinate with the centerline of inside hardware.

Width	Height	Thru-Bolt Pattern	Clearance Grip to Door	Projection
7-1/4"	11"	2" Wide x 10" High	1-1/2"	1-7/8"

Finishes

US Finish	US32D
BHMA	630

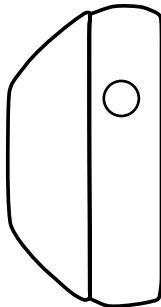

VR900LLP RH With black grip
VR900LLP LH With black grip
VR904LLP RH Without black grip
VR904LLP LH Without black grip

- For use with most mortise locks on outswinging doors including Schlage L9000 Series with interior L or N escutcheon, and rose trim.
- Includes built-in lock protector and cylinder cutout.
- Handed design allows trim to be positioned to coordinate with the centerline of inside hardware.

Width	Height	Thru-Bolt Pattern	Clearance Grip to Door	Projection
5-1/4"	11"	1-3/4" Wide x 10" High	1-1/2"	1-7/8"

Finishes

US Finish	US32D
BHMA	630

A
Hinges & Pivots

B11
Pulls & Plates

C
Flush Bolts & Coordinators

D
Latches, Catches & Bolts

E
Stops

F
Exterior Hardware

G
Miscellaneous Hardware

A	Hinges & Pivots
B12	Pulls & Plates
C	Flush Bolts & Coordinators
D	Latches, Catches & Bolts
E	Stops
F	Exterior Hardware
G	Miscellaneous Hardware

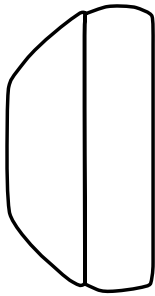

VR910-DT
VR914-DT

With black grip
Without black grip

- For use with Von Duprin 98/99 Series rim and vertical rod exit device
- Non-handed
- Thru-bolts direct to the exit device
- Pull operation only.

Width	Height	Thru-Bolt Pattern	Clearance Grip to Door	Projection
5-1/4"	11"	1-3/8" Wide x 7" High	1-1/2"	1-7/8"

Finishes

US Finish	US32D
BHMA	630

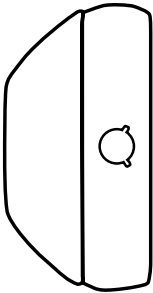

VR910-NL
VR914-NL

With black grip
Without black grip

- For use with Von Duprin 98/99 rim and vertical rod exit device
- Non-handed
- Thru-bolts direct to the exit device

Width	Height	Thru-Bolt Pattern	Clearance Grip to Door	Projection
5-1/4"	11"	1-3/8" Wide x 7" High	1-1/2"	1-7/8"

Finishes

US Finish	US32D
BHMA	630

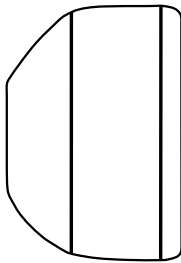

VR910M-DT **With black grip**
VR914M-DT **Without black grip**

- For use with Von Duprin 9875/9975 mortise lock exit device
- Non-handed
- Thru-bolts direct to the exit device

Width	Height	Thru-Bolt Pattern	Clearance Grip to Door	Projection
7-1/4"	11"	1-3/8" Wide x 7" High	1-1/2"	1-7/8"

Finishes

US Finish	US32D
BHMA	630

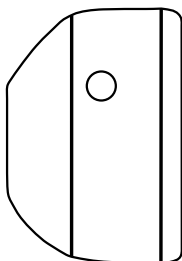

VR910M-NL RHR **With black grip**
VR910M-NL LHR **With black grip**
VR914M-NL RHR **Without black grip**
VR914M-NL LHR **Without black grip**

- For use with Von Duprin 9875/9975 Series mortise lock exit device
- Thru-bolts direct to the exit device
- Night latch operation (cylinder not furnished)

Width	Height	Thru-Bolt Pattern	Clearance Grip to Door	Projection
7-1/4"	11"	1-3/8" Wide x 7" High	1-1/2"	1-7/8"

Finishes

US Finish	US32D
BHMA	630

8400 Series Protection Plates

- Door protection plates are available in .050" thick brass, stainless steel or aluminum; and 1/8" thick high impact polyethylene in clear or black.
- Bevel edge options; specify B4E for all four edges.
- Mounting screw pack furnished standard, 16 screws per pack. Optional screw packs are available for TEK or TORK screw heads. Refer to the following chart for ordering.
- Specify NMH for no mounting holes.
- Specify NMH-A for no mounting holes with adhesive.
- Specify CS for counter sunk mounting holes.
- Specify ERS prepped with extra row of screws.

Kickplate Gasket Tape Tape is recommended when using a brass plate on a metal door to reduce tarnishing from electrolytic oxidation. One tape pack will cover an the perimeters of a 8" x 34" kickplate. Order 8401 Gasket Tape.



8400 Protection Plate
8402 (UL)* Protection Plate

*UL mark appears in upper right corner.

Number of screw packs required by plate size (specify TEK Screws or TORK screws).

	22"-25"	26"-33"	34"-41"	42"-48"
4"-8"	1	1	1	1
9"-16"	1	1	1	1
17"-24"	1	1	1	2
25"-32"	1	1	2	2
33"-40"	1	2	2	2
41"-48"	2	2	2	2

Finishes brass

US Number	US3	US4	US10	US10B	US15	US26	US26D
BHMA	605	606	612	613	619	625	626

Finishes stainless steel

US Number	US32	US32D
BHMA	629	630

Finishes aluminum

US Number	US28
BHMA	628

Finishes plastic

Clear and Black

Residential Grade Kickplates available Carded only, finishes PA28, PA3, PA619, PA716, B3, B505, B619, B716

A
Hinges & Pivots

B13
Pulls & Plates

C
Flush Bolts & Coordinators

D
Latches, Catches & Bolts

E
Stops

F
Exterior Hardware

G
Miscellaneous Hardware

A
Hinges & Pivots



Mop Plates

- Protect the bottom of the pull side of door subject to cleaning and mopping procedures.
- Size Ranges: 4" to 6" high, 22" to 48" wide

B14
Pulls & Plates



Kick Plates

- Protect the bottom of the push side of doors subject to scuffing from foot traffic.
- Recommended for all doors subject to normal use (especially doors using a closer).
- Size Ranges: 8" to 24" high, 22" to 48" wide

C
Flush Bolts & Coordinators

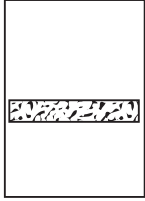

Stretcher Plates

- Protect doors at specific areas where consistent contact is made by stretchers, service carts or other equipment.
- Usually applied to push side of doors.
- Specify "B4E" Option for beveled edges.
- Size Ranges: 6" to 8" high, 22" to 48" wide

D
Latches, Catches & Bolts

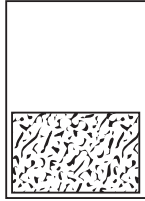

Armor Plates

- Protect lower half of doors from abuse by hard carts, trucks and rough usage.
- Usually applied to push side of single doors and both sides of double acting doors.
- Size Ranges: 26" to 48" high, 22" to 48" wide

E
Stops

F
Exterior Hardware

G
Miscellaneous Hardware

Mounting

- All mounting hardware is for standard 1-3/4" door.
- Consult Customer Service if other than standard.

Standard Mount

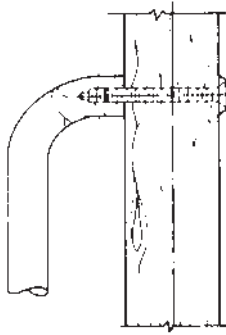

Standard Mounting

- (2) 1/4-20 x 2-1/4" brass, oval head machine screws; plated to match.
- (2) No. 14 countersunk washers; plated to match

Type G Mount

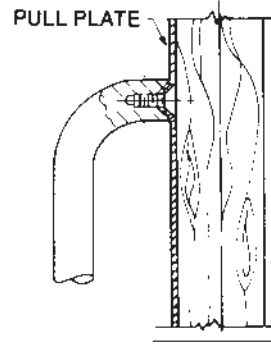

Concealed Pull Plate Mounting

- Available only for 8302, 8303, 8311 Pull Plates.
- (2) 1/4-20 x 5/8" steel flat head machine screws; zinc plated.
- Pull mounts directly onto plate.
- Plate is attached to door by 6 screws.

Type F Mount

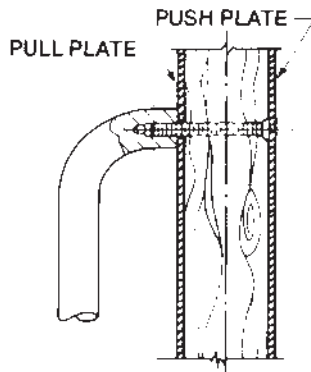

Wood Doors Concealed Pull Mounting With Push Plate

- (2) 1/4-20 x 2-1/4" steel flat head machine screws; zinc plated.

Available only for 8102, 8103, 8105, 8111, 8302, 8303, 8305 and 8311. Plate on opposite side of door must be ordered separately.

Type H-I-L Mount

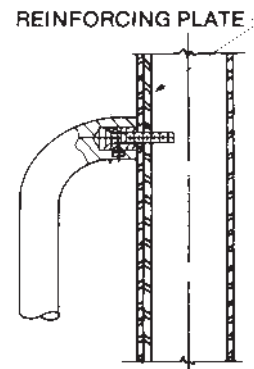

Reinforced Hollow Metal Door Concealed Pull Mounting

- Available only for 8102 8103, 8103EZ or wood door Pulls and 8302, 8303 pull plates.
- (2) Steel screw sleeves; zinc plated.
 - (2) 1/4-20 x 1-1/4" steel countersunk trim head machine screw; zinc plated for reinforced metal door.
 - (2) 1/4 x 1-1/2" steel countersunk trim head steel metal screw; zinc plated for wood doors.

Mounting

- All mounting hardware is for standard 1-3/4" door.
- Consult Customer Service if other than standard.

Type J Mount

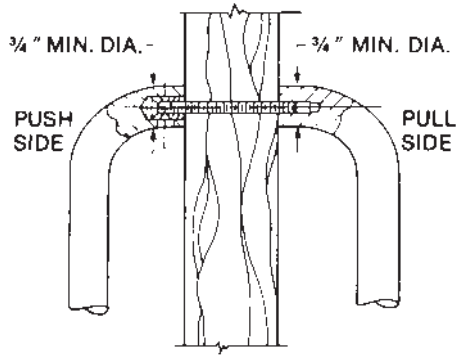

Back to Back Pull Mounting

Available only for 8102, 8103, Pulls and 8302, 8303 Pull plates.

- (2) Steel screw sleeves; zinc plated.
 - (2) 1/4-20 x 2-3/4" steel countersunk trim head machine screws; zinc plated.
- Pulls furnished in pairs (PR) unless single (SGL) specified.

Type K Mount

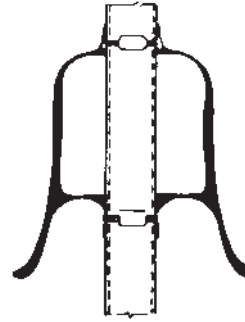

Back to Back Pull Mounting

Available only for 8121-5 Pulls.

- (4) Steel screw sleeve nuts; steel zinc plated.
 - (8) No. 8-32 x 1" brass oval head machine screws; plated to match.
- Pulls furnished in pairs (PR).

A
Hinges & Pivots

B16
Pulls & Plates

C
Flush Bolts & Coordinators

D
Latches, Catches & Bolts

E
Stops

F
Exterior Hardware

G
Miscellaneous Hardware

Mounting for 8103EZ, 8190, 9100, 9103EZ and 9190

- All mounting hardware is for standard 1-3/4" door.
- Consult Customer Service if other than standard.

Type M Mount

Back-to-Back with Spanner Collar

Wood or Metal Door

Available only for 8103EZ and 8190 Pulls.

- (2) 3/8-16 x 2-7/8" RH/LH bolts with finish matching spanner collars for tight, durable back-to-back mounting. Pulls furnished in pairs (PR) or Single (SGL) must specify M1 or RH thread or M2 for LH thread.

Type O Mount

Decorative Blind Thru - Bolt

Wood or Metal Door

Available only for 8103EZ, 8190 and 9100 series Push/Pull Combinations.

- (2) 1/4-20 x 2-1/4" blind thru - bolts; plated to match.

Type N Mount

Back-to-Back "Two-Anchor"

Wood or Metal Door

Available only for 8103EZ, 8190 and 9100 series Push/Pull Combinations.

- (2) 1/4-20 x 2-3/4" steel countersunk trim head machine screws with (4) set screws for maximum anchoring force.
- (2) Steel screw sleeves; zinc plated.

Type NO Push/Pull Mounting

Type N & Type O

Pushbar to Pull

- (1) 1/4-20 X 3" steel countersunk trim head machine screws with (2) set screws.
- (1) steel screw sleeve, zinc plated.

Free End Pushbar & Pull

- (2) 1/4-20 X 2-1/4" blind thru-bolts; plated to match.

Type NS-Standard Push/Pull Mounting

Type N & Standard

Pushbar to Pull

- (1) 1/4-20 X 3" steel countersunk trim head machine screws with (2) set screws.
- (1) steel screw sleeve, zinc plated.

Free End Pushbar & Pull

- (2) 1/4-20 X 2-1/4" brass, oval head mach screws; plated to match.
- (2) No. 14 countersunk washers; plated to match.

A
Hinges & Pivots

B17
Pulls & Plates

C
Flush Bolts & Coordinators

D
Latches, Catches & Bolts

E
Stops

F
Exterior Hardware

G
Miscellaneous Hardware

A
Hinges & Pivots

B18
Pulls & Plates

C
Flush Bolts & Coordinators

D
Latches, Catches & Bolts

E
Stops

F
Exterior Hardware

G
Miscellaneous Hardware